

Væg 1 Parkour.

Form nr.002
1.12.12

Product description:

Væg 1 is a box for Parkour.
The box is available in 5
different materials combination

Target group:

For Children from aged 6.

Safety requirements:

Væg 1 maintains the require-
ments described in EN 1176,
part 1 and 2 (2008 edition)

Technical specifications:

Se our cataloque page XX

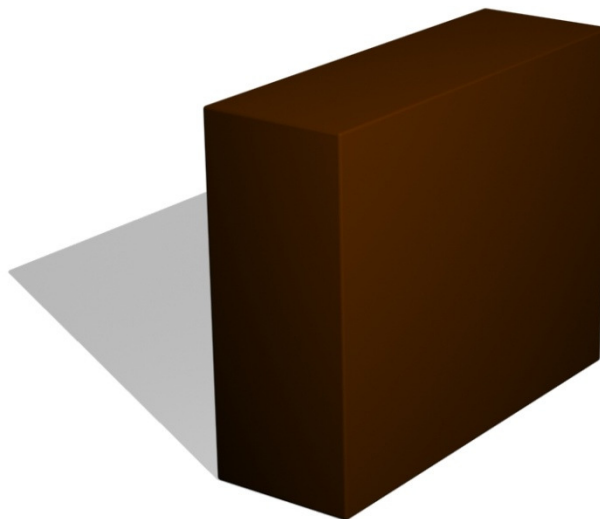

Væg 1 PP
Box in Plywood
Top in Plywood
Weight:

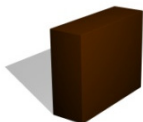

Væg 1 PG
Box in Plywood
Top in rubber
Weight:

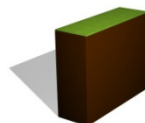

Væg 1 CC
Box in Concrete
Top in Concrete
Weight:

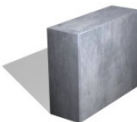

Væg 1 CG
Box in Fiber Concrete
Top in Rubber
Weight:

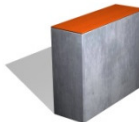

Væg 1 GG
Box in Rubber
Top in Rubber
Weight:

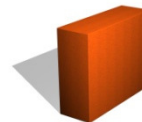

Color



Plan, safety zone

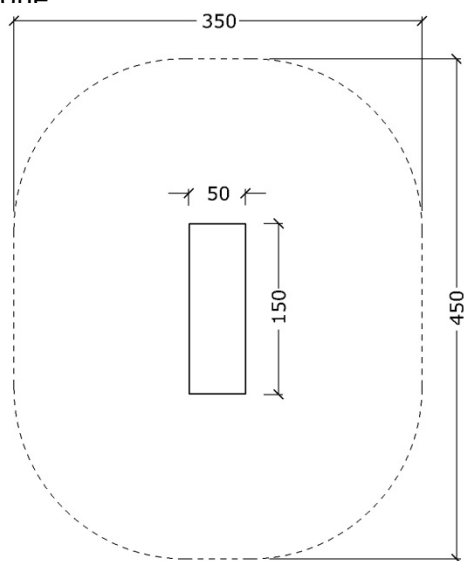

Elevation front, side

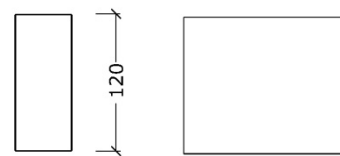

Fore most of our products are there developed one or more variants. If you want
more information please contact Noles A/S on
mail info@noles.dk or telephone +45 8686 1055

